

AUGUST 1973

# HEWLETT-PACKARD JOURNAL





# Automated Transceiver Testing

*A new computerized system is dedicated to production and maintenance testing of mobile transmitters, receivers, and transceivers in the communication bands from 10 MHz to 1000 MHz. Tests conform to EIA standards and include AM, FM, audio, and power tests.*

**by Dmitry A. Bobroff**

**R**ECENT RAPID GROWTH in the transceiver manufacturing and maintenance industries, coupled with the effects of inflation and greater emphasis on quality assurance in response to user demand, have sent the costs of transceiver testing dramatically upward. Automated testing is being seen as a solution—increasing throughput, minimizing test costs, and improving quality by accurate, thorough, and repeatable testing.

The new Hewlett-Packard 9540 Transceiver Test System, Fig. 1, is designed to meet these objectives. The system performs AM, FM, audio, and power tests for production and maintenance of mobile transmitters, receivers, and transceivers in the communication bands from 10 MHz to 1000 MHz.

Testing throughput with the 9540 System is much faster than manual testing. A complete production test of a typical final-assembly transceiver can be performed in about three minutes. An equivalent test done manually would take 15 to 30 minutes.

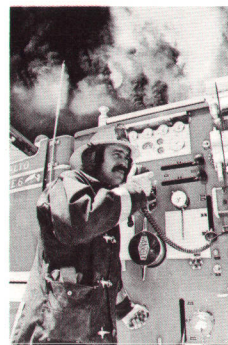
Besides being faster, 9540 testing is more comprehensive, that is, more tests can be performed than would be feasible manually. Also, the system can automatically generate failure-rate information that may reveal design problems, thereby aiding product improvement. Test probes supplied with the system can be used in combination with an appropriate user-written diagnostic program to accelerate troubleshooting of transceivers that fail the automatic tests.

## Tests Performed

In the United States, all transceivers are required to meet rigid Federal Communications Commission requirements for RF power output, AM modulation depth or FM deviation, frequency accuracy and stability, and spurious radiation. In other countries, equivalent government bodies impose similar re-

quirements. The U.S. Electronic Industries Association (EIA), a manufacturers' group, sets requirements for many additional parameters. To guarantee compliance, transceivers must be thoroughly tested not only on the production line, but also periodically while in service.

The 9540 system makes all of the EIA measurements normally encountered in a production environment. Excluded are tests of transmitter spurious radiation and intermodulation products, typically not done in production. Fig. 2 is a list of the tests performed. Detailed measurement capabilities and accuracy specifications are listed on page 7.

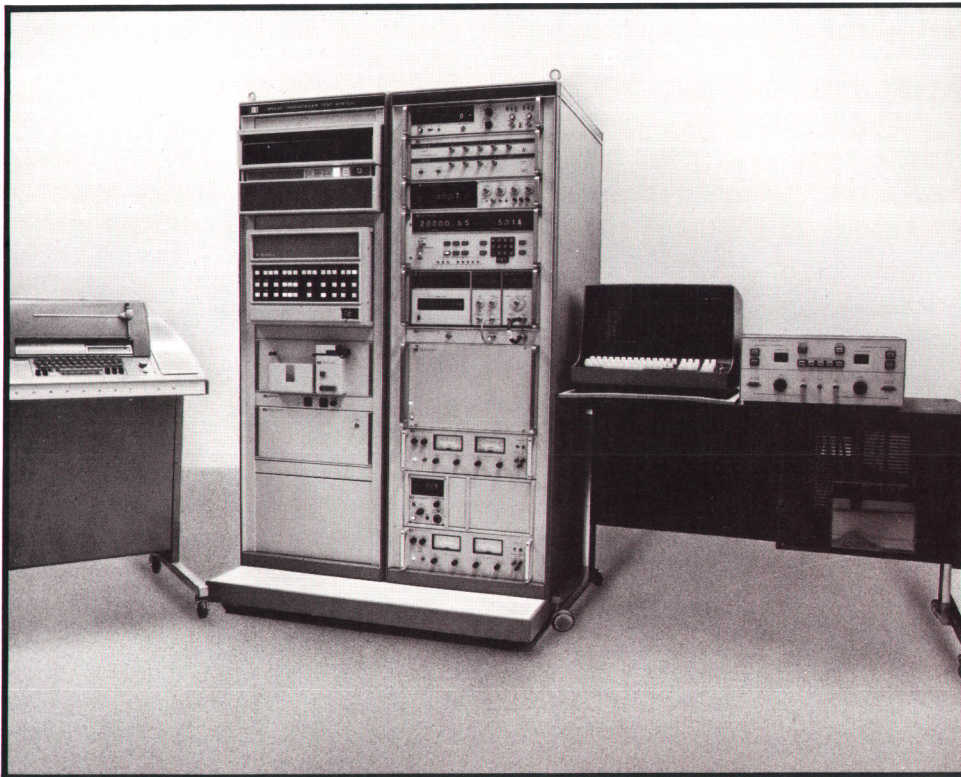


**Cover:** *There are times when an unreliable transceiver can contribute to a disaster. The HP 9540 Transceiver Test System helps assure reliability by improving quality control, and lowers test costs, too. Our cover photo is a composite, but the fire is a real one that recently destroyed a small HP warehouse. We thank the Palo Alto Fire Department for their assistance with the photo.*

## In This Issue:

- Automated Transceiver Testing, by Dmitry A. Bobroff . . . . .* **page 2**
- Signal Processing Techniques for Automatic Transceiver Testing, by Robert G. Huenemann . . . . .* **page 8**
- Digitally-Controlled Current Sources for New Ways of Making Automatic Measurements, by René Peerboom . .* **page 14**





**Fig. 1.** 9540 Transceiver Test Systems test receivers, transmitters, and transceivers five to ten times faster than manual methods. This is the full-capability Model 9540D disc-based system. A paper-tape system (Model 9540B) is also available.

### System Description

The 9540 Transceiver Test System is an integrated hardware/software automatic system consisting of computer and peripherals, programmable instruments, special interface and control panels, high-and-low-frequency switching, software routines for calculating transceiver parameters from fundamental measurements of voltage and time, an easy-to-use programming language, and a software operating system.

A feature of the new systems is a dual-port interface panel, or RF test head, that allows a second transceiver to be connected and warmed up while one is being tested, thereby maximizing testing

throughput. The RF test head can be separated from the system by a 15-foot cable so transceivers can be tested inside a screen room while the system remains outside (see "Shielding and Grounding," page 6).

The system is programmed in the HP ATS BASIC language, an automatic-test-system-oriented language that is easy to understand and use. An example test program based on EIA requirements is provided with the system. This program can be easily adapted by the user to a specific transceiver. Once the test engineer or skilled test technician has programmed the test sequence required, actual production testing can be done by operators of average skill using pushbutton system commands.

Transmitter (AM & FM)	Receiver (AM & FM)
Carrier Power Output	SINAD Sensitivity
Carrier Frequency	Quieting Sensitivity
Hum and Noise	Audio Sensitivity
AM Modulation Depth	Squelch Operation
Modulation Limiting	Audio Power Output
FM Deviation	Audio Distortion
Audio Distortion	Audio Frequency Response
Audio Frequency Response	FM Modulation Acceptance
	Bandwidth
	Hum and Noise Levels

**Fig. 2.** 9540 Systems make all EIA tests normally encountered in a production environment.

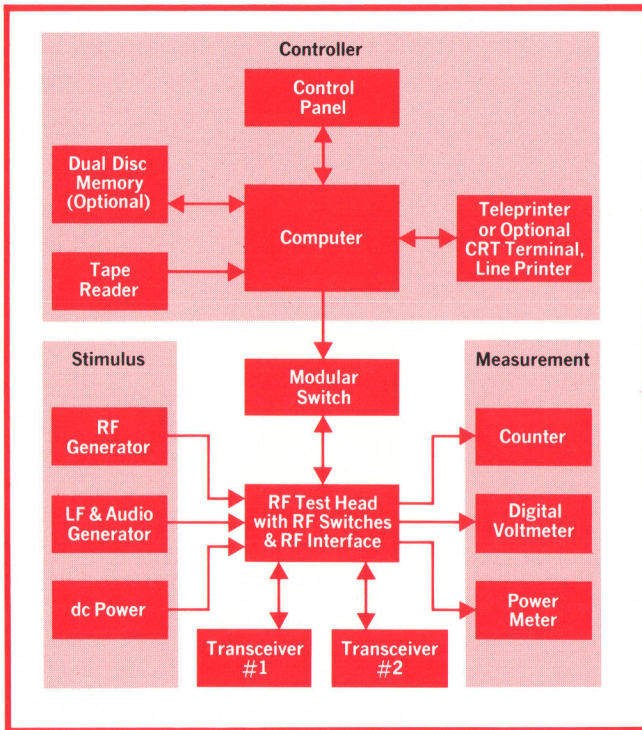
### Transceiver Test Hardware

Fig. 3 is a block diagram showing the hardware elements of the new transceiver test system. Transceivers to be tested are connected to the system at the RF test head, Fig. 4.

In the RF test head are a double-balanced mixer and other RF components for down-converting the transmitter frequency, a peak detector for AM measurements, and a thermistor mount for RF power measurements (Fig. 5). Also included are a programmable attenuator and programmable RF switches for setting up measurement paths.

On the front of the RF test head are two type N connectors for transmitter output and receiver in-

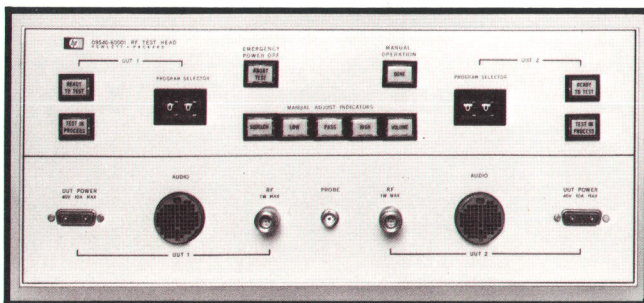




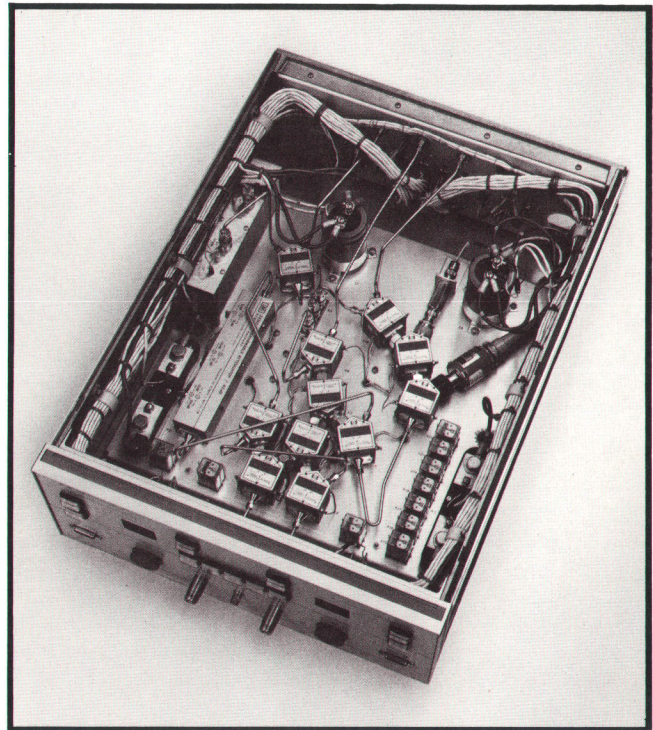
**Fig. 3.** Transceiver stimulus is provided by a signal generator and a frequency synthesizer. Measurements are made by a multimeter, a counter, and a power meter, supplemented by special software to compute distortion and other parameters. A modular switch sets up measurement paths under computer control.

put, two audio connectors for transceiver speaker and microphone input and output, and two connectors for supplying dc power to the two transceivers. A 500 MHz peak-detecting probe and a dc probe connect to the RF test head to aid in trouble-shooting faulty transceivers.

Pushbuttons on the RF test head provide for initiating a test or for terminating it under abnormal conditions. A two-digit thumbwheel switch selects the number of the test to be run. Indicator lights show which of the two transceivers is being tested,



**Fig. 4.** Transceivers to be tested are connected to this RF test head. Two units at a time can be connected; one can be warming up while the other is being tested. A 15-foot cable allows the test head to be inside a screen room while the system remains outside.



**Fig. 5.** Inside the RF test head are a down-converting mixer, a peak detector, a thermistor mount, a programmable attenuator and programmable RF switches.

and other indicator lights call for manual squelch or volume adjustments during tests.

Programmable instruments in the system include an RF signal generator, a frequency synthesizer, a power meter, a counter, and a digital voltmeter. A modular switch routes low-frequency signals from the RF test head to appropriate measurement instruments. The switch also provides for control of the programmable components in the RF test head.

The signal generator (HP 8660A Synthesized Signal Generator) provides RF signals from 1 MHz to 1300 MHz. For receiver testing it provides input stimulus; it can be programmed to a desired AM modulation depth or FM peak deviation. In transmitter tests it acts as a local oscillator for down-converting the transmitter frequency to below 100 kHz.

The frequency synthesizer (HP 3320B) provides audio-frequency modulation.

The power meter (HP 432C) measures transmitter power output. With an external 30 dB attenuator and the internal programmable attenuator the power meter can measure RF power from 1 watt to 100 watts full scale.

The electronic counter (HP 5326A) makes period measurements of down-converted transmitter signals for tests such as FM deviation, carrier frequency, and FM transmitter distortion.



The digital voltmeter (HP 3480B with sample-and-hold) samples low-frequency receiver waveforms for audio power output and audio distortion tests. It also measures resistances.

A teleprinter acts as a system control device for program development and provides hardcopy print-out of test results.

Options available include a CRT terminal, a line printer for faster hardcopy output, a digital clock to provide time of day and elapsed time information, and a multiprogrammer for programming power supplies to provide variable dc voltages to the transceiver under test.

### Transceiver Test Software

Two different software operating systems are used in 9540 Systems. Model 9540B uses the Test Oriented Paper Tape System (TOPTS), with programs loaded into core memory from paper tape. Model 9540D uses a disc-based executive called TODS (Test Oriented Disc System). TODS is designed to eliminate restrictions on the size and scope of software programs that might otherwise be limited by the available computer core memory. It provides for segmenting of programs on the disc and easy access to the various segments via program and subroutine linking. HP ATS-BASIC, FORTRAN, and HP Assembly Language are all compatible with TODS.

TODS also provides editing routines that can automatically delete or change source programs on the disc. This is important when new programs are being written and debugged.

Another important feature of TODS is the cata-

log and librarian system. As the system stores programs on the disc it catalogs their locations so they can easily be accessed by test routines. On command, the librarian will print out a list of the programs stored on any selected portion of the disc. It will also print the amount of space remaining on the disc.

Included in the operating system is a Transceiver Test Executive that scans the RF test head to determine which of the two ports is ready to test, initializes all switching, and initiates execution of the desired program.

Special software signal processing routines eliminate the need for specialized instruments such as a distortion meter or an FM deviation meter. There are routines for sampling voltages and instantaneous periods, and fast-Fourier-transform routines for deriving parameters such as rms value, rectified average value, rms distortion, and FM deviation. These routines are described in more detail in the article on page 8.

### Testing a Transceiver

The transceiver test system is supplied with a sample test program for making all typical tests on transceivers. This serves as a guide to the user in programming the system to test a particular transceiver. Thus program development time is minimized. The average user should be able to begin testing in a day or two, including the time required for electrical interfacing. Fig. 6 shows typical sample test program segments for carrier frequency measurement and audio output power measurement. Fig. 7 shows a typical printout of results.

Transmitter Program in BASIC (Carrier Frequency Accuracy)		
5	DSPLAY "TRANSMITTER ON"	Notice to operator
10	LET F = 48.32	Define RF frequency (F)
15	CTRSF (4,0,0)	Set function of counter
20	RFOSO (F, -5,0)	Set RF output
25	CTRMF (4,V0,1)	Measure period, store in V0
30	LET E = INT(1/V0-5000+0.5)	Find frequency error (E)
35	DSPLAY "CARRIER IS" E "HZ FROM" F "MHZ";	Display E in Hz
40	LET E8 = ABS(E/(10+6*F))	Calculate fractional error
45	IF E8>.00002 DSPLAY "FAILED"	Compare and display if over limit
Receiver Program in BASIC (Audio Output Power)		
1	LET F = 48.32	Define RF frequency (F) in MHz
5	ACVSV(1,1000,.5)	Set up modulation
10	DVMSU(5,10,0)	Set up DVM
15	RFOSO (F,0,-17)	Set RF output
20	RFOSM (2,1,3.3)	Set RF modulation
25	WAIT (5000)	Settle for 5000 ms
30	DVMMU (32,F(1),-1032)	Measure 32 samples of F(1)
35	RMS (32,F(1),V0)	Calculate rms value of V0 from F(1)
40	DSPLAY "AUDIO POWER IS" V0+2/3.2 "WATTS"	Calculate power and display value

Fig. 6. Sections of typical test programs written in ATS BASIC.



TRANSCIVER TEST POINT RESISTANCE MEASUREMENTS

AUDIO PIN NUMBER	9499B SWITCHES	RESISTANCE (OHMS)	REVERSE RESISTANCE
16	65 133	5.41	5.75
17	67 134	2.45	2.47
23	69 135	92400	16420
32	71 136	434000	45610
38	73 137	0.0000E+00	1.2600E+07
37	75 138	49100	1638
35	77 139	19.03	19.22
34	79 140	56.04	59.03
39	81 141	555.3	555.2
45	83 142	0000	0047
47	85 143	302.2	296.8
48	87 144	31.50	31.30
50	89 145	89.30	87.84
53	91 146	967.7	895.8
52	97 147	0.0000E+00	0.0000E+00
52	99 148	0.0000E+00	0.0000E+00
63	101 149	0.0000E+00	0.0000E+00
64	103 150	0.0000E+00	0.0000E+00
71	105 151	0.0000E+00	0.0000E+00
78	107 152	0.0000E+00	0.0000E+00
81	109 153	0.0000E+00	0.0000E+00
76	111 154	0.0000E+00	0.0000E+00

EIA RS-152-B FM TRANSMITTER TESTS AT 47.52 MHZ STATUS

TRANSMITTER CARRIER TESTS

AVERAGE SUPPLY VOLTAGE IS	13.71	VOLTS
AVERAGE SUPPLY CURRENT IS	11.45	AMPERES
PEAK SUPPLY CURRENT IS	11.47	AMPERES
CARRIER POWER OUTPUT IS	86.31	WATTS
PEAK AM HUM AND NOISE IS	82.74	DB DOWN
RESPONSE AFTER 100 HRS. IS	101	% OF VALUE AFTER 3 SEC.
CARRIER FREQUENCY ERROR IS	200	HERTZ
RMS FM HUM AND NOISE IS	47.87	DB DOWN

TRANSMITTER FREQUENCY RESPONSE

FREQUENCY (KHZ)	DEVIATION (KHZ)	ERROR (DB)
300	.36	-1.83
375	.476	-1.41
475	.648	-1.72
599	.837	-2.51
754	1.101	-1.13
949	1.447	-2.5
1194	1.89	-2.5
1590	2.201	-2.3
1890	2.68	-1.5
2380	3.21	-2.04
3000	3.199	-3.11

TRANSMITTER MODULATION LIMITING

DYNAMIC DEVIATION PEAKS ARE -3.7K AND 3.62 KHZ.

FREQUENCY (KHZ)	DEVIATION (KHZ)
300	2.574
375	2.693
475	3.135
599	3.309
754	3.480
949	3.595
1194	3.562
1590	3.738
1890	3.863
2380	4.190
3000	3.447

TRANSMITTER RMS FM DISTORTION IS 4.3 PERCENT

EIA RS-204 FM RECEIVER TESTS AT 47.52 MHZ STATUS

RECEIVER QUIETING TESTS

AVERAGE SUPPLY VOLTAGE IS	13.73	VOLTS
AVERAGE SUPPLY CURRENT IS	.58	AMPERES
PEAK SUPPLY CURRENT IS	2.64	AMPERES
QUIETING AT +107 DBM IS	26.33	DB
THRESHOLD QUIETING IS	74.80	DB
THRESHOLD SQUELCH CHECKED AT	-113	DBM
TIGHT SQUELCH CHECKED AT	-47	DBM

RECEIVER DISTORTION TESTS

AVERAGE SUPPLY VOLTAGE IS	13.72	VOLTS
AVERAGE SUPPLY CURRENT IS	.58	AMPERES
PEAK SUPPLY CURRENT IS	.26	AMPERES
AUDIO POWER OUTPUT IS	5.12	WATTS
SQUELCHED HUM & NOISE RATIO	87.05	DB
UNSQUELCHED HUM&NOISE RATIO	70.87	DB
RMS DISTORTION IS	0.97	PERCENT
SINAD AUDIO POWER IS	8.34	WATTS
SINAD AT +107 DBM IS	19.32	DB
MODULATION ACCEPTANCE BANDWIDTH SINAD AT +101 DBM IS 11.94 DB		*** TEST FAILED ***

RECEIVER FREQUENCY RESPONSE

FREQUENCY (KHZ)	OUTPUT (VOLTS)	ERROR (DB)
300	1.384	-7.68
375	1.342	-4.71
475	1.453	-3.23
599	1.32	-2.87
754	1.10	-3.7
949	1.04	-1.4
1194	.878	.30
1590	.734	.81
1890	.508	1.01
2380	.479	1.11
3000	.377	1.85

RECEIVER SPURIOUS RESPONSE TESTS

TESTS MADE AT AN RF LEVEL OF +29 DBM

DESIRED CHANNEL QUIETING AT	47.52	MHZ	69.72	DB
IMAGE QUIETING AT	46.02	MHZ	-1.80	DB
1 <sup>st</sup> QUIETING AT	10.7	MHZ	-1.3	DB
1 <sup>st</sup> QUIETING AT	4.55	MHZ	-0.51	DB

SWEEP SPURIOUS RESPONSE TEST FROM 200 KHZ TO 1.0 MHZ IN STEPS OF 1 KHZ. TEST REQUIRES 24 HOURS. TEST PRINTS ALL FREQUENCIES AT WHICH QUIETING EXCEEDS 10 DB. TEST LIMIT IS 90 DB.

FREQUENCY (MHZ)	QUIETING (DB)	HARMONIC	STATUS
3.109	13.44	15	
3.394	21.30	14	
3.558	25.05	13	
3.96	23.74	12	
4.32	23.48	11	
4.752	20.13	10	
5.28	19.85	9	
5.94	27.08	8	

## Shielding and Grounding

The 9540 RF test head is located at the end of 15 feet of cable (usable length from exit at rear of system to rear of test head) so the test head can be placed in a screen room. This keeps three things out of the screen room: the system bulk, the system heat dissipation, and radio-frequency radiation from the computer.

To minimize signal degradation by the cables between the system and the test head, transmitter output signals are down-converted to below 100 kHz at the test head, and in receiver testing, corrections are made for cable losses between the 8660A Signal Generator and the test head. Also, to preserve the integrity of the low-frequency signals between the test head and the system, special attention has been paid to grounding and shielding.

One vertical rail in the instrument bay has been chosen for use as a ground bus. All instruments are connected to this rail by heavy ground straps. The power-line ground is also connected to this rail.

The 9540 System provides 22 test point connections at each test head audio connector. These may be used as 11 shielded twisted pairs or as 22 measurement points to ground. Measurements can also be made between any two test points.

The shields are continuous from system to test head panel, where they are available to the user. They are grounded only at one point, the interconnect panel in the system, which in turn is grounded to the cabinet rail along with the instruments. The voltmeter guard is connected to the shield of its twisted-pair input cable which also is grounded to the interconnect panel.

With minor exceptions, the 9540 System ground paths are in the form of a tree rather than a mesh, so loops are avoided. This is especially true of the exterior connections between the system and the test head.

To test a transceiver, the operator first connects three cable harnesses between the transceiver to be tested and the RF test head. One harness is for RF, one is for audio, and one is for dc power. The operator then dials the number of his previously written test program for that transceiver (9540D system only) and presses the READY TO TEST button on the RF test head.

When this button is pressed the system begins execution of the selected program, turns out the READY TO TEST button lamp, and lights the TEST IN PROCESS lamp.

During the test, if a volume or squelch adjustment is necessary, the VOLUME or SQUELCH indicator will light. The operator then adjusts the appropriate transceiver control while watching the LOW, PASS, and HIGH indicator lamps on the RF test head. Having adjusted the control so the PASS indicator is lighted, he presses the DONE button and execution of the test program continues.

When the operator isn't adjusting controls he can connect a second transceiver to the RF test head. With the 9540D System the two transceivers can

Fig. 7. Typical test program printout.



be different types; with the 9540B they must be the same. When the current test is complete the system executive extinguishes the TEST IN PROCESS lamp, restores internal switching, and begins testing the second transceiver if it is connected and its READY TO TEST button has been pressed.

### Acknowledgments

A great many people contributed to the success of the project. Bob Huenemann was very instrumental in the overall system design and system concept definition as well as being the prime developer of the system. Stan Hyde and Marve Durland developed the software executive and coded the signal processing routines. Dick Cavallaro did the mechanical design on the RF test head as well as the other system components.

Brian Humphries assumed project manager responsibility toward the latter part of the project. John Cardoza and later Jim McCabe were responsible for product management. Production engineering was performed by Dale Milligan who assured the smooth transition of the 9540 from the lab to manufacturing.

Don Ried and Gene Brittain wrote the 9540 manuals. Dick Heintzleman, and later Gil Seymour, were the project coordinators.

Thanks are also due to Dale Ewy for his management insight and many helpful suggestions. 



### Dimitry A. Bobroff

Jim Bobroff recently became engineering section manager for analog and general-purpose test systems at the HP Automatic Measurement Division. Previously he was group manager for communications systems, including the 9540. At HP since 1968, Jim has been involved in a number of systems projects, including a computer communications interface and a multistation operating system.

Jim received his BSEE degree from the University of California at Berkeley in 1961 and his MSEE degree from New York University in 1963. Born in Shanghai, China, he also lived in Japan for several years before coming to the United States in 1951. Jim and his wife and three sons live in Saratoga, California. He's active in church affairs and enjoys skiing, travelling, stamp collecting, and reading.

## SPECIFICATIONS

### HP 9540 Transceiver Test System

#### GENERAL SPECIFICATIONS

**TRANSCIVER TYPES:** AM or FM  
**TRANSCIVER FREQUENCY RANGE:** 10 MHz to 1 GHz  
**TRANSCIVER OUTPUT POWER RANGE:** 1 Watt to 100 Watts

#### RECEIVER MEASUREMENT ACCURACIES

##### Sensitivity Measurements<sup>2</sup>

(SINAD, Quieting, Squelch Sensitivity & Clamping)

##### RF LEVEL SETTABILITY:

±1.5 dB from -25 dBm to -127 dBm, resolution 1 dB (-127 dBm = 0.1 μV @ 50Ω), up to 500 MHz

##### FM DEVIATION SETTABILITY:

±5% of setting

##### AM MODULATION DEPTH SETTABILITY:

±5% of setting

#### Output Measurements

##### AUDIO RMS DISTORTION ACCURACY:

Reading ±1% for measurements up to 25% distortion levels at 1 kHz modulating frequency

##### AUDIO POWER OUTPUT ACCURACY:

±1% ± Load resistor tolerance at 1 kHz

##### HUM AND NOISE:

60 dB below rated receiver output level

##### AUDIO FREQUENCY RESPONSE ACCURACY:

±0.2 dB, 50 Hz to 3 kHz

#### TRANSMITTER MEASUREMENT ACCURACIES

##### Carrier Measurements

##### CARRIER POWER OUTPUT ACCURACIES:

±0.4 dB, 100 MHz to 1 GHz

±0.7 dB, 30 MHz to 100 MHz

±1.2 dB, 10 MHz to 30 MHz

Input VSWR = 1.1

##### CARRIER FREQUENCY ACCURACY:

<6 × 10<sup>-7</sup> over 6 month period

<6 × 10<sup>-8</sup> over 24 hour period

##### AM HUM AND NOISE:

60 dB below rated output

##### FM HUM AND NOISE:

55 dB below rated deviation, at 3 kHz deviation (750 μs pre-emphasis) and 1 kHz modulation frequency

#### Modulation Measurements

##### FM DEVIATION ACCURACY:

±3% of reading from 50 Hz to 3 kHz modulating frequencies, 500 Hz to 15 kHz peak deviation

##### AM MODULATION ACCURACY:

for modulating frequencies 50 Hz to 1 kHz			
modulation depth	30%	70%	95%
reading ±	1%	2%	5%
for modulating frequencies up to 3 kHz			
modulation depth	30%	70%	95%
reading ±	2%	4%	10%

##### MODULATION LIMITING ACCURACY:

Same as FM deviation and AM modulation measurement accuracies

##### AUDIO SENSITIVITY ACCURACY:

FM: ±4% of reading

AM: ±5% of reading at 1 kHz modulation frequency

##### AUDIO FREQUENCY RESPONSE ACCURACY:

±0.5 dB, 50 Hz to 3 kHz

##### AUDIO RMS DISTORTION ACCURACY:

Reading ±1% for measurements up to 25% distortion levels at 1 kHz modulating frequency

**NOTES:** 1. Transceivers with power levels lower than one watt or higher than 100 watts can be tested using special attenuators.

2. Input settability accuracy and audio rms distortion measurement accuracy determine SINAD sensitivity measurement accuracy.

3. Specification represents rms uncertainties of the measurement system but does not include mismatch uncertainty due to transmitter VSWR.

4. Deviation must be greater than modulating frequency.

**PRICE IN U.S.A.:** 9540D, \$128,000; 9540B, \$110,000 (plus options).

**MANUFACTURING DIVISION:** AUTOMATIC MEASUREMENT DIVISION  
 974 East Arques Avenue  
 Sunnyvale, California 94086 U.S.A.



# Signal Processing Techniques for Automatic Transceiver Testing

*Here's how the 9540 System tests transceivers to EIA standards using only a voltmeter and a counter.*

by Robert G. Huenemann

**M**ANY TRANSCEIVER PARAMETERS are not measured directly by 9540 Systems but are computed from sampled voltage and frequency measurements. Special software routines have been developed for this purpose.

Readers familiar with modulation theory, sampled data theory, and Fourier analysis will immediately recognize the type of signal processing techniques used by 9540 Systems. Readers who would like additional background will find references at the end of this article.<sup>1, 2</sup>

## Sampled Voltage Measurements

Sampled voltage measurements would be simple if high-speed analog-to-digital converters were available as inexpensive system components. This is because sample timing considerations are much simpler if analog-to-digital conversion rates are high enough to permit all samples to be taken over one cycle of the waveform of interest.

However, a system such as the 9540 must provide a resistance measurement capability as well as voltage measurements. This makes a digital voltmeter with sample-and-hold circuitry an overwhelmingly cost-effective system component.

Typically, such voltmeters have more than enough digits of resolution and a suitably narrow aperture, but a low digitization rate—1 kHz, in the case of the HP 3480B used in the 9540 System. This means that samples must be taken over many successive cycles of a waveform (which must, of course, be repetitive) using a sampling-oscilloscope approach (see "Sample Timing Considerations," page 11).

**Rms Value.** The 9540 BASIC software includes a call

RMS (N, V (K), V)

which computes the rms value V of N sampled

voltages that have been stored in an array V (K).

This call can be used on a series of measurements taken by the 3480B Voltmeter in sample-and-hold mode to determine the rms value of an ac waveform such as a receiver output voltage.

**Rectified Average.** The 9540 call

AVG (N, V (K), V)

computes the average of the absolute values of N sampled voltages that have been stored in an array V (K).

This call can be used on a series of measurements taken by the 3480B Voltmeter in sample-and-hold mode to determine the average value of an ac waveform, or the value V can be multiplied by 1.11 to determine the rms sine-wave equivalent, which is the value that would be read by many D'Arsonval type meters with rms scales.

**Peak Noise.** The 9540 call

PEAKS (N, V (K), V1, V2)

will return the highest and lowest values V1 and V2 of N sampled voltages from an array V (K).

This call can be used on a series of measurements taken by the 3480B Voltmeter to determine such parameters as peak-to-peak noise of a power supply voltage.

**Distortion.** The 9540 BASIC user software includes a series of routines that allows the rms distortion of a waveform to be computed from a series of 32 sampled values of that waveform. The samples must be timed properly to coincide with either one waveform period or many successive periods as in a sampling oscilloscope. In this way, the waveform can be re-created within the limits of Nyquist's sampling theorem. From these samples, the 9540 user can call a 32-point fast Fourier transform (FFT) with the call

FFT (32, V (K), W (1,1))

where K is the address of the first sample point



measured by the voltmeter and  $W(1,1)$  is the first entry in a table of trigonometric coefficients. The FFT uses the Bergland algorithm<sup>3</sup> to return the values of the spectrum of the waveform to the same array. The spectrum is in the form of a dc term, 30 sine and cosine components of the fundamental frequency and harmonics 2 through 15, plus one component of the 16th harmonic.

These components are in the scrambled order which is typical of in-place transformations. Therefore the software includes a call

```
ORDER (16, V(K), U(J))
```

which combines the sine and cosine components into magnitudes on an rms basis and arranges them in order of ascending frequency.

Finally, the rms distortion can be obtained by using the call

```
DIST (16, U(J), D)
```

on the output array of the ORDER call to obtain the rms percent distortion relative to total rms power from the waveform spectrum. In this way, the distortion of a waveform can be determined without using a hardware distortion analyzer (Fig. 1).

### AM Peak Detector Linearization

In AM measurements, an HP 8471A Diode Peak Detector is used to demodulate the waveform. The output of the detector is measured by the 3480B voltmeter, and all the sampled voltage measurement techniques described above are then useful in one way or another.

The use of the distortion routine is obvious, and

the PEAKS routine can be used to find modulation depth and residual peak noise.

The only problem is that diode peak detectors are nonlinear at low input levels. In a computer system this can be corrected because the system has the computing power and speed to do a linearization on each set of measured data points (Fig. 2).

To calibrate the peak detector transfer function, a series of CW RF levels from the 8660A Signal Generator is applied to the peak detector, and the detector output is measured by the DVM. The system includes an automatic switched path for this purpose. Next, because the power measurement accuracy of the 432C Power Meter is better than the 8660A output-level specification, the system switches the 8660A to the 432C, using another automatic path, and repeats the level measurements. RF peak voltage levels are computed from these power measurements, and these RF peak voltages are stored in a calibration table along with the corresponding outputs from the peak detector as measured by the DVM.

In subsequent AM measurements, the dc sample values are converted to equivalent peak RF levels, using the calibration table and a linear interpolation routine, AMINT. Above the maximum value of the table (10 dBm is the upper limit of signal generator output), the peak detector can be assumed to be linear.

### Sampled Frequency Measurements

To test FM transceivers, it's necessary to make sampled measurements of frequency as well as of voltage. For this the system uses an HP 5326A Counter as a low cost "frequency-to-digital" converter, since there are as yet no instruments designed specially for digital FM demodulation. The salient features of this instrument are that its best resolution is obtained in the period mode, it can only measure alternate periods of a waveform, it can do so at sampling rates up to 100 kHz, and its period-mode resolution is 0.1 microsecond.

The period-mode frequency-to-digital converter (counter) cannot be timed like an analog-to-digital converter. However, average timing can be controlled by controlling the average test frequency. This is done by down-converting all signals that go to the counter to below 100 kHz, using as a local oscillator the HP 8660A Signal Generator, whose frequency can be precisely adjusted. This average down-converted frequency is measured using the counter's period-average mode, and this information is used to make small corrections to the 8660A frequency (see "Sample Timing Considerations," page 11 ).

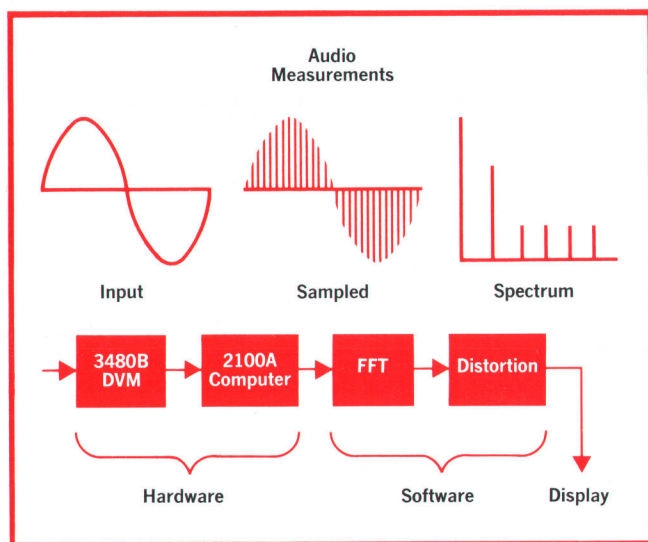


Fig. 1. In audio distortion tests, sampled measurements followed by fast-Fourier-transform and distortion-computation routines do the job of a hardware distortion analyzer.



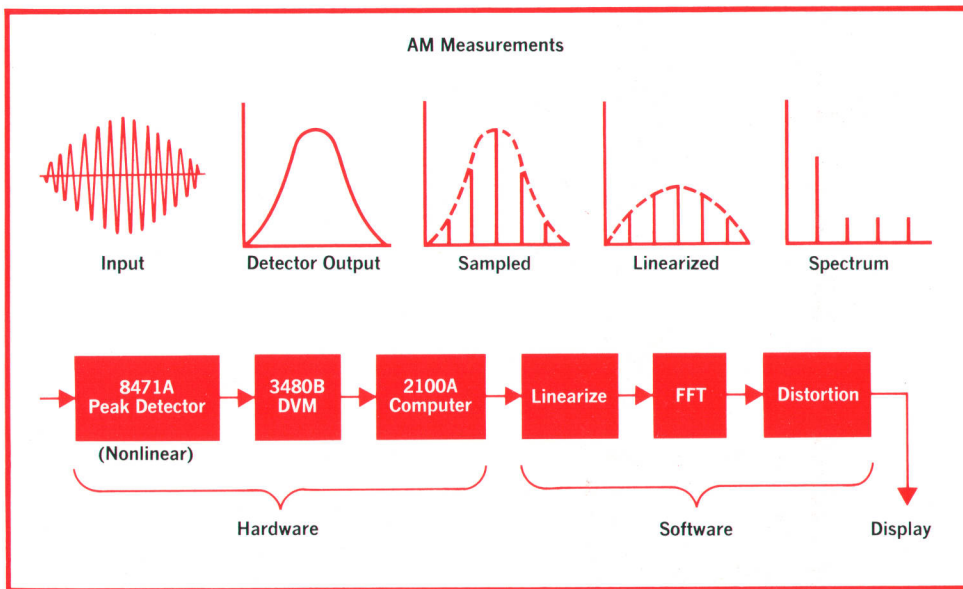


Fig. 2. In AM tests, the system compensates for detector non-linearity. Linearization is a signal processing capability that isn't practical using only hardware.

**Peak Deviation.** To measure peak-to-peak FM deviation, the 9540 System makes a series of 101 period measurements on an FM waveform and determines the high and low peak values using the PEAKS call discussed previously. The system compensates for the relatively poor period-mode resolution of this counter by down-converting the FM signal before feeding it to the counter. The clock frequency of the counter is 10 MHz and the resolution is specified at  $\pm 1$  count or 0.1 microsecond.

In choosing the frequency for down-conversion, several sources of error must be considered. The period-mode resolution of any counter gets better as the period is increased. This would favor down-conversion to a very low frequency, except for another source of error, namely measurement-time error. The longest period of the down-converted FM wave should not exceed 10% of the modulation period for the measurement-time error to be less than 1.64% for sine-wave modulation.<sup>4</sup> Thus measurement time error increases with modulation frequency if a fixed down-conversion frequency is used. If the down-converted frequency is increased, resolution error increases, so the deviation measurement accuracy is better at lower modulation frequencies.

Yet another source of error has to do with the statistical likelihood of having a deviation peak fall exactly at the center of the measured period. If 100 random samples are taken, this error is reduced below 0.1% with a confidence level of 0.96 (see Ref. 5).

In the 9540, timing relative to the modulation period is chosen in such a way that even higher confidence levels are achieved. Modulation frequencies of interest go to 3 kHz. Thus 101 measurements can-

not be made over one modulation cycle. To maximize the probability of measuring peak values, the down-converted carrier frequency is set to  $101/N$  times the modulation frequency, where 101 is prime and  $N$  is an integer.  $N$  is chosen to keep measurement time error below 1.64% and to keep all measured frequencies above 1 kHz. The upper limits on deviation and modulation frequency are then determined by the allowable resolution error.

The last source of error is triggering error due to noise, which is a function of applied signal level. This level is kept high by stepping up the mixer output with a wideband (1 kHz to 100 kHz) transformer before applying it to the counter. In this way, trigger circuit noise is minimized as a source of error. The sideband noise of the local oscillator used in down-conversion is also unimportant compared to resolution and measurement-time errors.

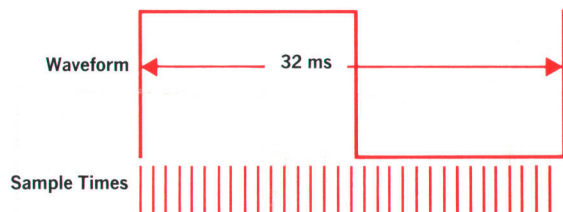
**Rms FM Distortion.** This is perhaps the most interesting 9540 measurement. A method was developed for sampling the instantaneous frequency of a sinusoidally frequency modulated wave, using only the 5326A Counter. From these samples, the rms distortion can be computed. This avoids the need for a hardware discriminator or demodulator, a distortion analyzer, and a hardware de-emphasis network.

The measurement consists of a series of period-mode measurements on the down-converted waveform over one period of the sine wave modulation. These measurements describe the time between successive zero crossings of the down-converted carrier waveform. The timing information is inherent in the measurements, because the starting time of each measured period is the sum of all previous periods.

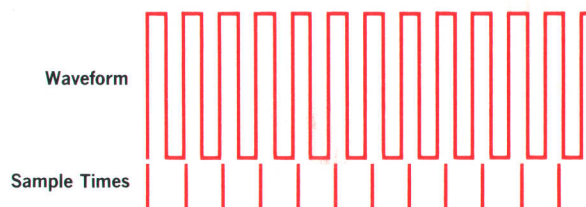


## Sample Timing Considerations

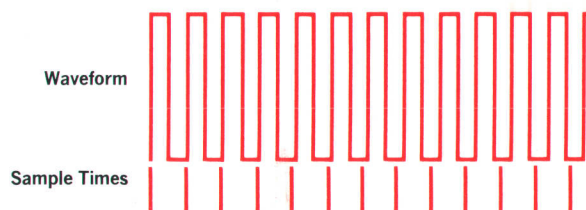
Most of the signal processing routines used in 9540 Transceiver Test Systems require 32 samples representing one cycle of the waveform of interest. The HP 3480B Digital Voltmeter will take at most 1000 samples per second. This is fast enough to take the required 32 samples over a single period of a waveform for waveform frequencies up to about 31 Hz, as shown below.



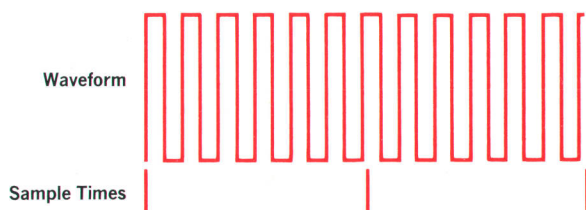
If the waveform of interest has a frequency higher than 31 Hz, the system uses a sampling-oscilloscope approach, taking 32 samples over more than one period of the waveform. The simplest case consists of 32 successive cycles of some repetitive waveform, as shown below. It can be seen that each successive sample falls a little later in the cycle (by  $1/32$  of a cycle).



An equally valid approach is to sample 32 times over 31 cycles, as shown below. Here, each sample falls a little earlier on each successive cycle.



For a given upper sampling rate, a slightly higher signal frequency can be handled if the samples are taken over 32 cycles rather than 31. Even so, the input frequency is limited to about 1030 Hz unless cycles are skipped between samples:



To measure a 2 kHz waveform, 32 samples can be taken over 64 (or 63) cycles. At the upper 9540 System frequency specification of 6 kHz, the 32 samples are taken over at least 191 cycles of the waveform.

For the sampled measurements to be accurate, it is crucial that timing correspond *exactly* to the number of cycles of the waveform. This is especially true for distortion measurements, where timing accuracies of a few parts per million are needed to reduce timing errors to the 0.1% level for samples taken over 32 cycles.

In 9540 Systems, the voltmeter timing is set by the computer, and the signal source for either transmitter or signal-generator modulation is usually the 3320B Synthesizer. To increase timing stability, the synthesizer and computer are both tied to the high-stability 8660A Signal Generator time base. This eliminates relative time base drift as a source of error.

The voltmeter driver allows the time between samples to be set anywhere between 32,768 microseconds and about 1000 microseconds (the voltmeter's minimum digitization time) in one-microsecond increments. The synthesizer can be set in 1 Hz increments in the non-vernier (phase-locked) mode, up to 1300 Hz.

For cases where  $1 \mu\text{s}$  timing resolution and 1 Hz frequency resolution aren't adequate, there are two possibilities. One is to use frequency/timing combinations that are in good agreement. For example, 1014 Hz can be used for many "one kilohertz" tests with a frequency error of only 1.4%. A sample-to-sample timing of 1017 microseconds then gives 32 samples over 32 cycles with a distortion error due to timing of less than 0.08%, whereas at 1000 Hz and the best corresponding timing of 1032 microseconds the distortion error can reach 1.6%.

If a particular frequency, such as 3 kHz, *must* be used, cycles can be skipped between samples if a better frequency/timing correspondence can be achieved in this way. For example, at 3 kHz a measurement over 96 cycles with a timing of 1031 microseconds can yield a distortion error of 8%, but if the measurement is taken over 127 cycles with a timing of 1323 microseconds, the distortion error due to timing will be less than 1.6%. The timing becomes progressively more critical as the sample spacing is increased. However, the major jump in required timing accuracy occurs in going from 32 samples per cycle to one sample per cycle.

A BASIC-language algorithm furnished with 9540 Systems helps the user select frequency/timing combinations consistent with his accuracy and measurement speed requirements. Fortunately, the required timing accuracy is greatly reduced for a simple sampled voltage measurement (RMS or AVG), as compared to a distortion computation.

An additional consideration in frequency selection is that the highest frequency in the sampled spectrum must not be so high as to cause aliasing error.<sup>2</sup> In some cases, filtering may be necessary. If the bandwidth of the 3480B/3484B DVM (12 kHz on the 0.1 V range) doesn't provide enough filtering to prevent aliasing, the HP 5489A Low-Pass Filter that is a part of each 9540 System can be switched in to further restrict the input bandwidth.

### Frequency Measurements

For FM distortion measurements, the timing is relatively straightforward. At a 1 kHz modulation frequency, the HP



5326A Counter data rate (100 kHz) is adequate to allow the required number of samples to be taken over two periods of a modulation cycle. The down-converted carrier is set at 33 times the modulation frequency, or 33 kHz.

The measurement is done in two steps. First the nominal transmitter carrier frequency is used to set up an initial signal-generator offset frequency. The mixer output frequency is then measured in the counter's period-average mode over 1000 periods or more (to minimize the effects of FM modulation on the measurement). This measurement is then used to correct the signal-generator frequency so the down-converted carrier frequency is 33 times the modulation frequency ( $\pm 0.5$  Hz for signal generator resolution). 33 alternate periods are then measured over two modulation cycles and the computation proceeds as described in the text of this article.

In FM deviation measurements, the timing is governed by a number of considerations. 101 period measurements are taken, to increase the probability of capturing the peak values. Modulating frequencies go as high as 3 kHz. The counter will not take 101 measurements in  $\frac{1}{3}$  millisecond, so the down-converted carrier frequency is set to 101/N times the modulation frequency, where 101 is a prime number and N is an integer chosen by a BASIC-language algorithm to achieve a balance between the counter resolution and measurement time errors discussed in references 4 and 5 and the text of this article. By using 101/N for the ratio of carrier frequency to modulation frequency any possible synchronism between the modulation and carrier frequencies is avoided, thus further increasing the probability of having a deviation peak fall at the center of a measured interval.

As in the FM distortion measurement, the complete deviation-measurement sequence consists of a carrier frequency measurement in the period average mode, followed by a signal-generator frequency adjustment and the 101-value array measurement.

Each period measurement can be inverted to find the frequency at the middle of that period. These midpoints are of course not equally spaced in time, but linear interpolation can be used to compute the values of frequency at a set of equally spaced times. These values can then be used in a Fourier analysis.

The dc term in the resultant spectrum is the carrier frequency. The spectrum can be de-emphasized by 750 microseconds to correspond to the standard test receiver used for these measurements,\* and rms distortion can then be computed, using the DIST call described previously.

The major complication is that the 5326A, like all counters presently available, will not measure each of the carrier periods of the down-converted waveform. It will in fact only measure every other period of the waveform.

To overcome this limitation, the carrier period information is measured over two modulation pe-

riods, and the down-converted carrier frequency is set exactly to an odd multiple of the modulation frequency (see page 11). It then turns out that the carrier periods measured during the second modulation cycle are precisely those periods which were

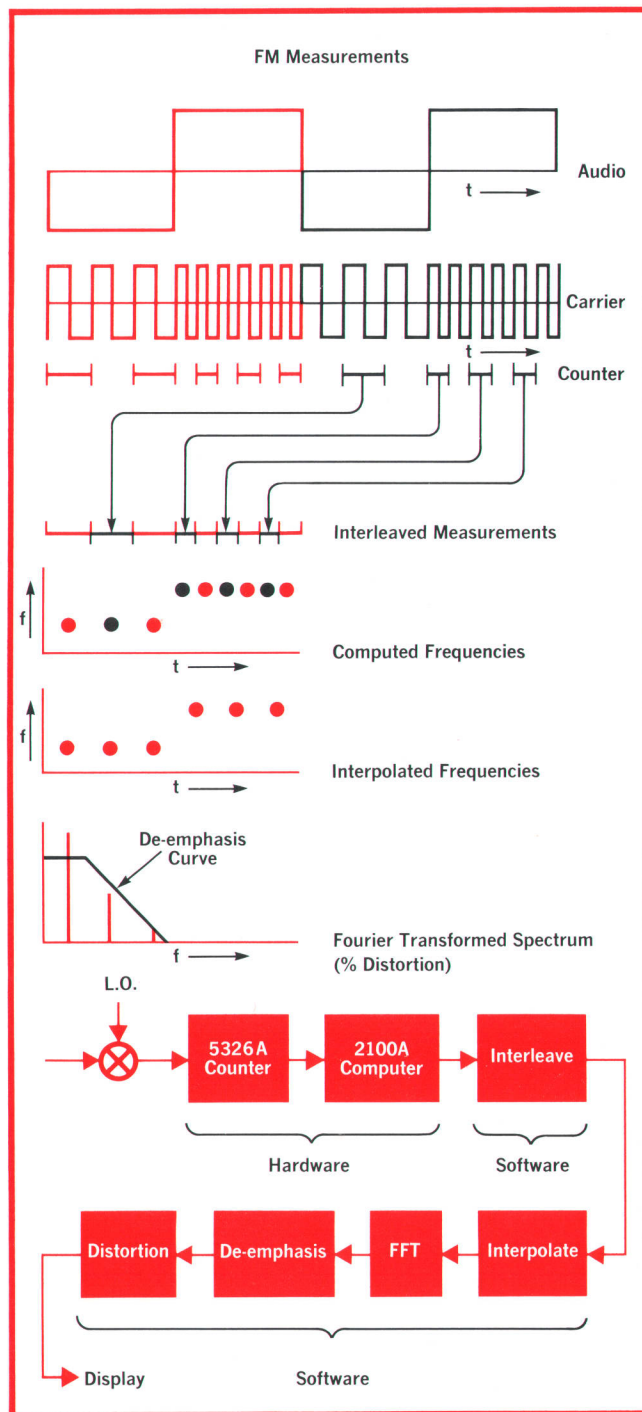


Fig. 3. In FM measurements the counter, acting as a frequency-to-digital converter, measures every other carrier period over two modulation cycles. These measurements are interleaved and a set of equally-spaced frequency samples is computed. These are transformed to derive the spectrum and determine distortion.

\*De-emphasis is equivalent to multiplying the spectrum by the transfer function of a single-pole RC filter having a time constant of 750  $\mu$ s. This is done to compensate for the standard pre-emphasis curve used in communications transceivers.



skipped during the first. The values can be interleaved as shown in Fig. 3 to obtain a complete representation of one period, and the computation continues as described above.

Once the carrier frequency has been set, the sequence is as follows.

CTRMA (33, F (1))	Measure 33 periods
PERIOD (33, F (1), F (34))	Interleave and store at F (34)
FMINT* (33, F (34), F (1))	Interpolate 33 periods into 32 frequency samples equally spaced in time. Store in F (1)
FFT (32, F (1), W (1, 1))	Fourier transform 32 points
ORDER (16, F (1), F (32))	Order and compute 16 magnitudes
DEEMP (16, F (32), 1000)	De-emphasize spectrum of 1000-Hz signal by 750 $\mu$ s
DIST (16, F (32), D)	Compute rms distortion D

**Rms FM Hum and Noise.** The principal point that needs to be made about this measurement is that it is *not* a peak-to-peak residual FM measurement. The measurement is in fact made almost exactly like the rms distortion measurement just described. The down-converted carrier is set to 33 times the fundamental expected hum component (60 Hz or 50 Hz, as appropriate). The measurements are interleaved, interpolated, Fourier-transformed, and ordered to get the hum spectrum.

The transformed channels are wide enough that noise is also recovered. A de-emphasis of 750 microseconds is applied, and the rms value of the hum and noise is computed from the rms sum of all spectral components except the dc term, which again represents the down-converted carrier frequency. Note that if the hum and noise were computed directly from a series of samples in the time domain, there would be no way to apply de-emphasis to the spectrum.

#### Acknowledgments


Jim Overman wrote the BASIC and assembly language Bergland FFT algorithm. He also devised the special 3480B driver that gives us microsecond timing resolution. Both of these contributions were crucial to the success of the 9540 signal processing routines.

Fred Brown made the revisions to the 5326A driver that allow array measurements at a 100 kHz data rate.

Stan Hyde and Marve Durland converted many, many routines from BASIC to assembly-language and generated the configured software systems to

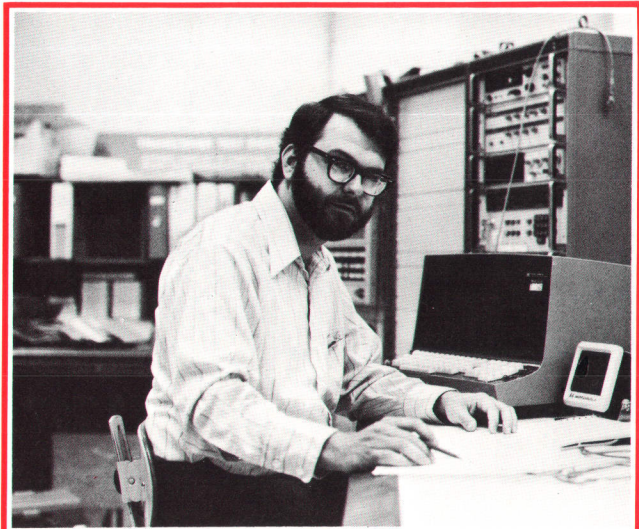
\*This linear interpolation is sufficiently different from the AM case that it is convenient to use separate calls and drivers.

use them. Mal Spann generated the final software configuration.

Many other persons from several HP divisions made suggestions that helped to achieve an effective hardware/software balance in the 9540. Their interest is greatly appreciated. Irv Klein, Ray Tattman, and Jim Francis of the HP Automatic Measurement Division were especially helpful in getting me "up to speed" about the division's capabilities and methods. Jim Bobroff offered many helpful criticisms and suggestions. 

#### References

1. Mischa Schwartz, "Information Transmission, Modulation, and Noise," McGraw-Hill, 1959.
2. P. R. Roth, "Digital Fourier Analysis," Hewlett-Packard Journal, June 1970.
3. Glenn D. Bergland, "A Fast Fourier Transform Algorithm for Real-Valued Series," Communications of the ACM, Vol. 11, No. 10, October 1968, pp. 703-710.
4. "High Resolution FM Deviation Measurements," Hewlett-Packard Application Note CCA-33.
5. "Peak-Peak Deviation of an FM Transmitter or Receiver," Hewlett-Packard Application Note CCA-1.



#### Robert G. Huenemann

Bob Huenemann came to HP in 1971 with 12 years' experience in radio and radar design and contract research. He was the principal designer of the 9540 Transceiver Test System and its software signal processing techniques. Bob's BSEE degree is from the University of Wisconsin (1959) and his MSEE degree is from the Illinois Institute of Technology (1971). He's authored several papers on receiver spurious responses. An amateur radio operator, he's held the Extra Class license since he was 17. He also enjoys motocross, but the biggest demand on his leisure hours these days is playing fiddle with his bluegrass band, "The Goldrush."



# Digitally-Controlled Current Sources for New Ways of Making Automatic Measurements

*Using a digitally-controlled current source as the stimulus in automatic test systems simplifies some measurements, improves others, and makes some easy that would be hard to do any other way.*

By René Peerboom

**W**HEN A CONSTANT-CURRENT STIMULUS is needed in an automatic test system, the usual practice has been to use a resistor in series with a programmable voltage source. As long as the series resistor is large enough, the impedance of the device under test has little effect on the current.

This method works very well in many cases. Achieving accuracy, however, is not always practical. For example, suppose the breakdown voltage of a rectifier is to be measured with 1 mA current flowing and with a voltage compliance of 50 V expected. This is equivalent to a 50 k $\Omega$  load.

Suppose also the measurement error is not to exceed 5%. By the usual 10:1 rule of thumb, the current therefore should be maintained within 0.5% of 1 mA. This says that the ratio of the series resistance to the load resistance should be 200:1, meaning a series resistance of 10 M $\Omega$  in this case. Now then, supplying 1 mA through a 10 M $\Omega$  resistor requires a potential of 10,000 V.

To make constant current available for automatic testing without the problems associated with trying to adapt voltage sources, a new programmable constant-current source has been developed in two versions (HP Models 6140A and 6145A, Figs. 1 and

2). These supply up to 160 mA and have the speed and accuracy desired for automatic testing as well as the data storage and input isolation needed for digital control.

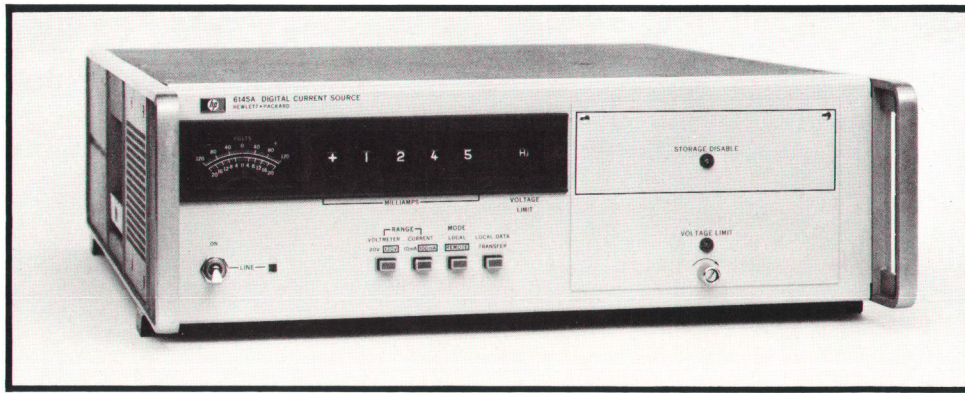
Designed for easy incorporation into a variety of automatic test systems, the new precision Current Sources can be programmed by computers, calculators, a pocket programmer, and other types of digital controllers. Plug-in cards allow the user to select a variety of input codes and logic levels. The instrument can be programmed by straight binary inputs or by BCD signals. In addition, the Model 6145A can be programmed from the front panel, allowing the instrument to be operated without a system controller.

Input commands are stored internally, freeing the controller for other tasks between programmed output changes. Data storage also eliminates the output transients that otherwise would result from unequal propagation times or from ringing in the cables carrying the digital commands to the instrument (Fig. 3). Digital inputs are isolated from instrument ground by optoelectronic isolators so no ground loops are formed when the instrument is incorporated into a system.



**Fig. 1.** Model 6140A Digitally-Programmable Current Source supplies current accurately at levels up to  $\pm 160$  mA in response to digital input commands. It accepts various logic levels and formats according to interface circuit boards that are installed through the removable panel on the front-panel.





**Fig. 2.** Model 6145A performs identically to 6140A, but has front-panel controls for operating the instrument manually.

The instruments respond quickly to new commands, bringing the output to within 0.1% of the programmed value in less than 0.3 ms following a new command.

### Constant Current vs. Constant Voltage

Measurements of resistance, semiconductor breakdown voltages, magnetic field intensity, and relay pull-in characteristics are just a few of the applications for which precision constant-current sources are particularly well suited.<sup>1</sup> There are some situations in which either a constant-voltage or constant-current source could be used, but the measurement is simpler with constant current—measuring resistance, for example. This measurement could be made using an ammeter to read the current forced through a resistor by a constant voltage, but with this method any voltage drops in the power supply leads must be accounted for. Measurements of small resistances are particularly troublesome this way because of contact resistance

in the connection to the unknown. What's more, the ammeter reading is *inversely* proportional to resistance, requiring some interpretation to get the true value.

On the other hand, when the measurement is made using a constant-current source, a voltmeter reads the voltage across the resistance so it is not necessary to account for contact resistance or voltage drops in the power supply leads. Furthermore, the measured voltage is directly proportional to resistance, so with suitable choice of ranges the readout can be direct-reading.

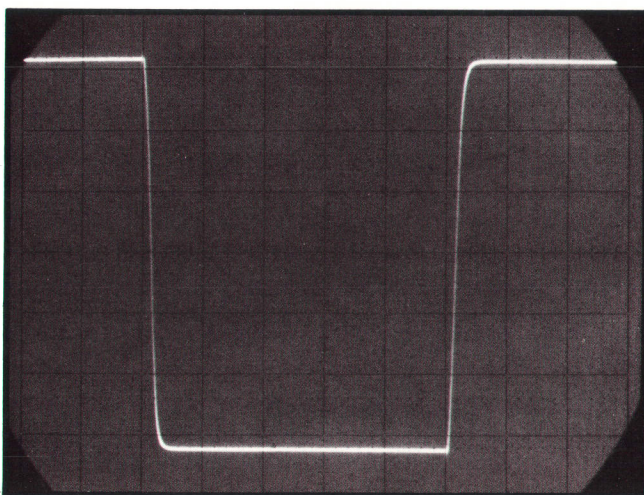
Another example of how a constant-current source simplifies measurements is the measurement of the capacitance of large electrolytic capacitors. By programming the computer to measure the time taken for a constant current to charge the capacitor to a selected voltage level, an accurate measurement is obtained very quickly.

### Current Range

The new Current Sources supply current at levels from  $-160$  to  $+160$  mA ( $\pm 100$  mA with BCD input) with  $5 \mu\text{A}$  resolution and with an error of less than  $10 \mu\text{A} + 0.005\%$  of setting. Voltage "compliance" is as much as  $\pm 100$  V.

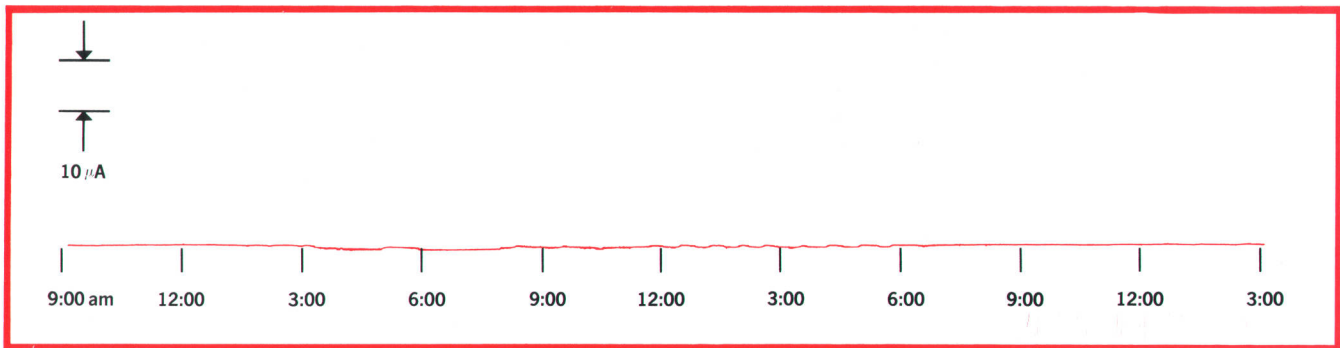
The instruments actually have two ranges. The  $\times 10$  range gives the  $\pm 160$ -mA capability just described. The  $\times 1$  range, however, is limited to  $\pm 16$  mA ( $+10$  mA with BCD input) but it gives  $10\times$  finer resolution:  $0.5 \mu\text{A}$ . Accuracy is then  $1 \mu\text{A} \pm 0.005\%$  of setting. The instruments' stability (Fig. 4) is such that there is no need to provide a current monitor in systems using the new current sources.

The instruments make it possible to superimpose an externally supplied analog waveform on the dc output. This allows dynamic measurements to be performed, such as measurement of zener diode dynamic impedance, by varying the output while maintaining the average dc current at a selected level.



**Fig. 3.** Oscillogram shows clean response of new current sources to changes in output level. Initial output level was  $+160$  mA; the instrument was then programmed across its full output range to  $-160$  mA, then back to  $+160$  mA. Oscilloscope sweep speed is  $100 \mu\text{s}/\text{cm}$ .





**Fig. 4.** 30-hour recording shows stability of new Digital Current Sources with a constant load (110 mA at 68 V) and in a constant ambient temperature. Ac line power, however, was not constant.

### Leak-Proof Constant Current

Maintaining accuracy with a current source requires strict attention to possible leakage paths. Any leakage from the high terminal to the low terminal along any path — through wire insulation, across circuit boards, etc. — adds to or subtracts from the output current thus causing an error in the current delivered to the load.

Leakage currents within the new Current Sources are minimized by a guard shield that surrounds all conductors and components connected internally to the output. As shown in Fig. 6, page 17, the guard is driven so it is always within  $\pm 10$  mV of the "High" output terminal. Any leakage current that might be attracted to the high terminal is intercepted by the guard so it does not detract from the output current.

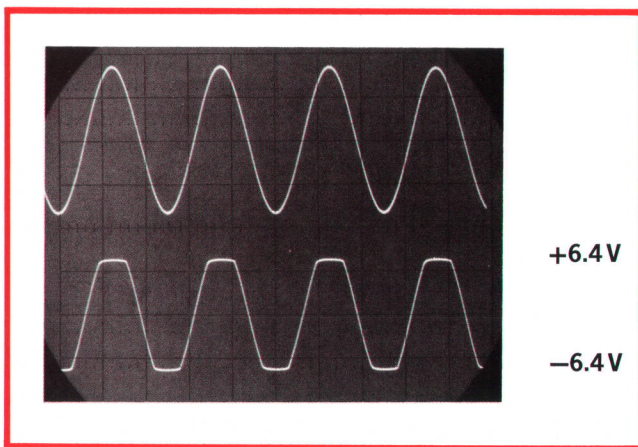
The guard can be extended to external circuits by connecting the shield surrounding the external

circuit to the rear-panel guard terminal.\* The guard also provides a means of measuring the voltage at the output terminals without drawing current from or altering the impedance of the main output. Since the guard voltage closely tracks the output voltage, the output voltage may be measured at the guard terminal with no effect on the output current. This arrangement is used internally for the front-panel voltmeter. (The maximum that the guard can supply to external circuits is 1 mA.)

### Constant Current Generation

Basically, the operation of a constant-current power supply is similar to a constant-voltage supply except that the control circuit monitors the voltage developed across a current-monitoring resistor rather than the voltage developed across the output. The current-derived voltage is compared to a reference and the difference between the two is used as a control signal for the series regulator. The output voltage is thus brought to a level that drives the load at the selected current level. If the load impedance changes, the output voltage changes accordingly so the current is always stabilized at a value determined by the internal reference.

A change to a high load impedance could cause the output voltage to go dangerously high as the supply seeks to maintain the current at the selected level. To protect the tested device in the event of an overvoltage condition, the new Constant Current Sources have voltage limiters that can be programmed to any one of eight levels between 2 and 100 V (positive and negative limits are programmed simultaneously with one command). Whenever the voltage reaches the selected limit, the limiters start diverting current away from the load and when the voltage goes 1.4 V beyond the limit, the output clamps at this level (Fig. 6) and a front-panel indi-



**Fig. 5.** Effect of voltage limiting is shown by this oscillogram. Upper trace shows 11.5 V p-p output of the current source in response to a sinusoidal waveform at the analog input. In the lower trace, the voltage limiters have been set to  $\pm 5$  V, resulting in hard limiting at 1.4 V beyond the selected level.

\*Note: the external shield must not link the guard with either output terminal.



cator turns on, alerting the user to the overvoltage condition. This information is sent to the controller on two voltage-limit status lines, one that turns off again whenever the output drops below the voltage limit, and one that stays on until reset so the operator can know if a transient voltage-limit situation had occurred during the course of a test program.

As a further protection for the load, the instruments automatically switch to the lowest voltage limit ( $\pm 2$  V) on turn-on, and remain there until commanded to switch to a programmed limit. Also, if the controller cable should become disconnected accidentally, or if a thermal switch on the heat sink should respond to an excessive temperature condition, the instruments automatically switch to the minimum voltage limit and open a relay in series with the output (K2 in Fig. 6). The operator can also invoke the minimum voltage at any time by using an override line that can be wired into a system "panic" button.

### Inside the Digitally-Controlled Current Source

Digital data for selecting the output current level is brought into the Digital Current Source on 15 lines. In addition, there is a line for range ( $\times 1$  or  $\times 10$ ) and one for polarity (+ or -).

The least significant data bit selects an increment of  $0.5 \mu\text{A}$  (on the  $\times 1$  range), the next selects an increment of  $1 \mu\text{A}$ , and so on up to an increment of  $8.192 \text{ mA}$  for the 15th bit. The output equals the sum of the increments corresponding to the bits that are in the "1" state times the range ( $\times 1$  or  $\times 10$ ).

When the polarity bit is in the "1" state (-), then the output equals the sum of the bits that are in the "0" state. In other words, data for negative currents is supplied in the 2's complement form.

The data goes to logic circuits that translate the input logic levels to the levels used by the instrument, then it passes through optoelectronic isolators. Plug-in cards enable the translation to accom-

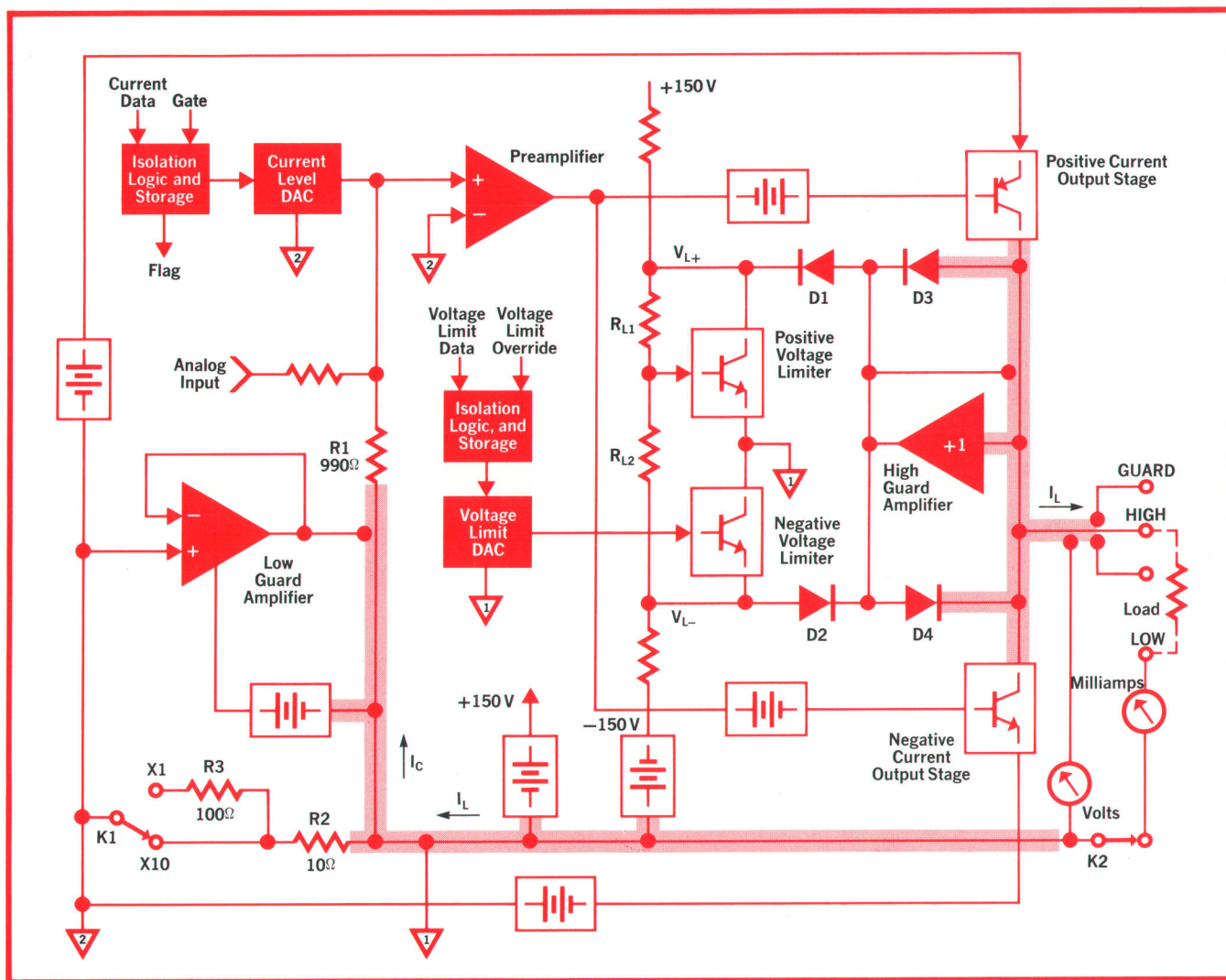


Fig. 6. Block diagram of new Digital Current Source.



modate a variety of input logic levels. A card can also be changed to allow use of binary-coded-decimal inputs.

The controller also transmits a gate signal that causes the input data to be stored in IC flip-flops. After an appropriate delay (50  $\mu$ s without range change, 2 ms with), the Digital Current Source transmits a flag to the controller, telling the controller that the data may be removed from the input lines.

The voltage-limit data is accepted, translated, and stored in the same way. Three binary inputs are provided for the voltage data, giving eight limits (2, 5, 7, 10, 20, 50, 70, 100 V).

The storage flip-flops operate switches in the current-level digital-to-analog converter (DAC), as indicated in the block diagram of Fig. 6. The DAC contains resistor-ladder networks of the type used in the HP Model 6130A/B Digitally-Controlled Voltage Source<sup>2</sup>.

The DAC output is a current,  $I_c$ , proportional to the desired output level,  $I_L$ , but of opposite polarity. This current flows through resistor R1, developing a voltage that is applied to the preamplifier and subsequently to the output stages. The resulting output voltage drives current through the load.

The returned load current passes through the low terminal to the current monitoring resistor R2 (and R3 on the  $\times 1$  range). The polarity of the resulting voltage across R2 is such as to reduce the input to the preamplifier to zero. This negative feedback action thus makes the voltage across the current-monitoring resistors equal to the voltage across resistor R1.

The current  $I_c$  subtracts from the load current  $I_L$  passing through the monitoring resistor. The current  $I_s$  in the monitoring resistors thus equals  $I_L - I_c$  or,

$$I_L = I_c + I_s$$

Since the voltage drops across R1 and R2 are equal and, in the  $\times 10$  range,  $R1 = 99R2$ ,

$$I_L = I_c + 99 I_c = 100 I_c$$

Similarly, on the  $\times 1$  range with relay K1 activated,  $I_L = 10 I_c$ .

The effective output impedance achieved by this configuration is greater than  $5 \times 10^9$  ohms in the  $\times 1$  range, and greater than  $0.5 \times 10^9$  ohms in the  $\times 10$  range.

### Internal Leakage Reduction

The instrument has two internal ground references. The LOW output terminal is connected to ground  $\nabla$ . Because of the voltage drop in the current-monitoring resistor(s), the power supplies for the output stages are referenced to ground  $\nabla$ . The

other circuits are referenced to the appropriate one of these two grounds.

Because leakage currents between grounds  $\nabla$  and  $\nabla$  would in effect be load current that by-passes the current-monitoring resistors, and would thus degrade output accuracy, steps were taken to prevent such leakage. This was done by surrounding the ground  $\nabla$  conductors with a second guard driven by an amplifier referenced to ground  $\nabla$ . This guard is thus at ground  $\nabla$  potential, intercepting any leakage paths from ground  $\nabla$  to ground  $\nabla$ .

The guard is implemented by running printed-circuit traces parallel to and on either side of traces that carry ground  $\nabla$ , using hygienic construction to inhibit leakage from ground  $\nabla$  to the guard. If there should be any such leakage, it is recirculated to ground  $\nabla$  by way of the guard amplifier and its power supply, thus assuring that leakage causes no net change in the current delivered to the current-monitoring resistors.

The high guard system, for preventing leakage between the HIGH and LOW output terminals, was described earlier.

### Output Configuration

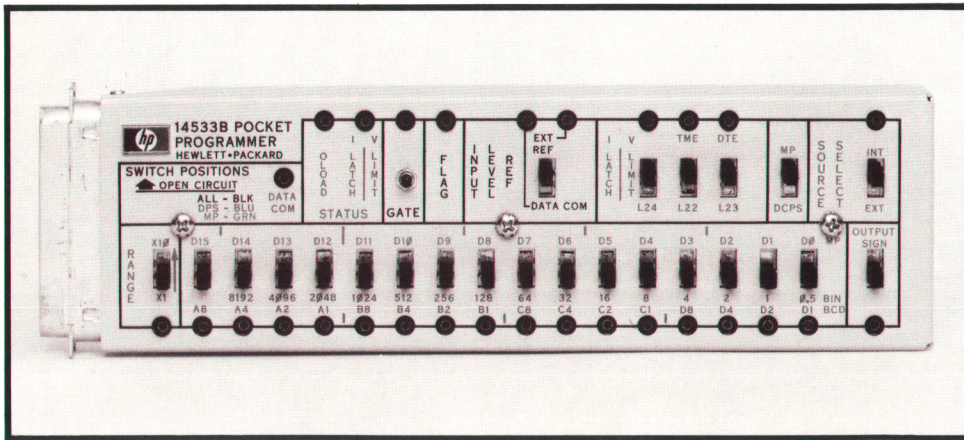
The output stages are connected in a complementary push-pull configuration. Bias levels are chosen so that a quiescent current level of 50 mA flows through the output stages at the zero output current level. Increasing the current supplied by one stage while reducing that supplied by the other then causes current to flow in the external load. As shown by the waveforms of Fig. 5, this arrangement assures a smooth transition from one output polarity to the other, unlike those systems that use a unipolar output stage and reverse output connections at the zero level when going from one polarity to the opposite.

Frequency compensation networks within the circuits maintain high output impedance at frequencies up to 25 kHz. This not only insures fast response to programming commands, but it also suppresses transients resulting from fast changes in load impedance.

### Limiting

The voltage limiters are connected in an auto-tracking configuration that allows one DAC to set both positive and negative limits. The DAC generates a negative voltage and the emitter of the negative voltage limiter output stage clamps to this level ( $V_{L-}$ ). This voltage tends to pull down on the positive-voltage-limiter input, resulting in an opposite action at its output ( $V_{L+}$ ). Because of feedback through resistor  $R_{L1}$ , the system stabilizes with the





**Fig. 7.** Pocket programmer, shown here without interconnecting cable, enables the Model 6140A Digital Current Source to be operated manually for off-line service and calibration or for use on the lab bench. Programmer operates all the Current Source input functions by switch closures.

positive voltage-limiter input at the same level as the emitter, which is at ground  $\nabla$ . By making  $R_{L1}$  equal to  $R_{L2}$ , the positive voltage limit  $V_{L+}$  thereby assumes the same magnitude as the negative limit  $V_{L-}$ .


Whenever the magnitude of the output voltage exceeds either voltage limit, the corresponding diodes, D1-D3 or D2-D4, will be forward-biased and will bypass current around the load so the regulator system will not attempt to increase the voltage substantially. This current is passed to ground  $\nabla$  by the corresponding limiter. Power handling capabilities of the limiters are more than adequate to absorb the maximum output current.

Circuits (not shown) that sense an overload condition, turning on the front-panel indicator and transmitting this information to the controller, respond to the voltage drop across the diodes. Hence, these circuits respond when the magnitude of the output voltage exceeds the selected limit by 1.4 volts, at which point the diodes are fully on and the output voltage cannot increase further.

To prevent any leakage through the diodes during normal operation of the supply, diodes D3 and D4 are bootstrapped to the output voltage by way of the high guard amplifier.

### Acknowledgments

Tom Milkowski developed software drivers included as part of the 14535A HP Computer Interface Kit. The power transformer, which has very low leakage, was designed by Frank Carlone. Mechanical design, which meets IEC specifications for spacing of electrical conductors, was by Ed Coffin and Tony Stanislaw. Tony, along with Robert Harrison and Bill Darcy, did the circuit-board layout, meeting stringent anti-leakage requirements. In a joint effort with the author, Earl Gable and Robert Harrison developed an automatic production test system. Much helpful advice and encouragement was provided by

Jack Durnin, Brad Bunker, Jim Gallo, Jack Leber, Art Darbie, and Dennis Monticello. 

### References

1. J. C. Perkinson and Willis C. Pierce, Jr. "Precision DC Current Sources" Hewlett-Packard Journal, September 1969.
2. B. M. Nordgren "Systems-Oriented Digital Power Sources," Hewlett-Packard Journal, June 1968.



### René Peerboom

René Peerboom first left his native Venezuela to learn English at New York's Columbia University. He returned later to get an engineering degree, attending the Newark College of Engineering nights while working days as a technician on test instrumentation for ceramics manufacture, electrochemistry, and telemetry. On getting his degree (BSEE, 1969), he accepted a teaching fellowship at NCE and continued his studies on a graduate level (MSEE, 1971).

René joined the HP New Jersey Division in mid-1970, going to work on digital power sources. He became project leader for the 6140A Digital Current Source six months later and is now group leader for digital power sources.

René is married and has two daughters, 4 and 2. Although he played on the Venezuelan national champion high school soccer team, he now finds little time (or opportunity) for that and the other sports he likes, swimming and tennis.



## SPECIFICATIONS

### HP Models 6140A and 6145A Digital Current Sources

**INPUT POWER:**

115/230 Vac  $\pm$  10%, 48-440 Hz, 1.6 A, 184 VA at 115 Vac.

**OUTPUT POWER:**

$\times 1$  Range: -16.3840 to +16.3835 mA @ 100 Vdc.  
 $\times 10$  Range: -163.840 to +163.835 mA @ 100 Vdc.

**SINK CURRENT COMPLIANCE:**

A sink condition results from an active load attempting to force energy back into the DCS. This can appear as current flow into the HI output terminal when the terminal is positive, or current flow out of the terminal when it is negative. In either case, active load terminal-to-terminal voltage is limited to 100 Vdc and the maximum current that the DCS can safely sink is 163.84 mA.

**BASIC DC CURRENT ACCURACY** (at 23°C  $\pm$  3°C, 115 Vac input, following 30 minutes warm-up):

$\times 1$  Range: 1  $\mu$ A  $\pm$  0.005% of programmed output.  
 $\times 10$  Range: 10  $\mu$ A  $\pm$  0.005% of programmed output.

**SOURCE EFFECT** (Change in output current for any change in line voltage from 104 to 127 Vac or 208 to 254 Vac):

$\times 1$  Range: 200 nA  
 $\times 10$  Range: 500 nA

**LOAD EFFECT** (Change in output current for any output voltage change within rating):

$\times 1$  Range: <20 nA  
 $\times 10$  Range: <200 nA

**TEMPERATURE COEFFICIENT:**

$\times 1$  Range: 150 nA + 0.0006% of programmed output current/ $^{\circ}$ C.  
 $\times 10$  Range: 1.5  $\mu$ A + 0.0006% of output current/ $^{\circ}$ C.

**DRIFT** (DC output current drift under constant line, load and ambient temperature for 8 hours after 30 minutes warm-up):

$\times 1$  Range: 0.5  $\mu$ A  
 $\times 10$  Range: 5.0  $\mu$ A

**PARD (RIPPLE AND NOISE):** DC to 50 MHz at any line voltage and under any load condition within rating:

$\times 1$  Range: 0.5  $\mu$ A rms/2  $\mu$ A p-p  
 $\times 10$  Range: 2  $\mu$ A rms/8  $\mu$ A p-p

**TRANSIENT RECOVERY TIME** (Time required for output current to recover within 0.1% of full range current following full load voltage change):

$\times 1$  or  $\times 10$  Range: 150  $\mu$ sec.

**PROGRAMMING TIME** (Maximum time required for output to settle within 0.1% of programmed current change after simultaneous receipt of data and gate signals with resistive load connected across output terminals):

$\times 1$  or  $\times 10$  Range: 300  $\mu$ sec.

**STORAGE DISABLE:** In this mode, digital inputs bypass storage flip-flops; output remains at programmed level only while digital inputs are present.**ANALOG INPUT** (should be floated\*):

IMPEDANCE: 600  $\Omega$

MAXIMUM INPUT VOLTAGE:  $\times 1$  Range: 16 V  
 $\times 10$  Range: 16 V

BANDWIDTH (to -3 dB Point): Approximately 25 kHz.

DC GAIN:  $\times 1$  Range: -1 mA/V  
 $\times 10$  Range: -10 mA/V

**STABILITY** (8 hours):

$\times 1$  Range: Same as stability of input signal +0.5  $\mu$ A.  
 $\times 10$  Range: Same as stability of input signal +5  $\mu$ A.

**OPERATING TEMPERATURE:** 0°C to +55°C.**COOLING:** Forced air.**ACCESSORIES AVAILABLE:**

POCKET PROGRAMMER, Model 14533B. This accessory permits manual programming of all input functions by switch closures.  
HP COMPUTER INTERFACE KIT, Model 14535A. Includes computer I/O card, cable, verification software and BCS driver.

**PRICES IN U.S.A.:** 6140A, \$2500.00    14533B, \$147.00 (with cable)  
6145A, \$2900.00    14535A, \$1650.00

**MANUFACTURING DIVISION:** NEW JERSEY DIVISION  
Green Pond Road  
Rockaway, New Jersey 07866

\*If analog input is grounded, output ripple increases approximately 15 $\mu$ A in  $\times 1$  Range and 150 $\mu$ A in  $\times 10$  Range.

Hewlett-Packard Company, 1501 Page Mill Road, Palo Alto, California 94304

Bulk Rate  
U.S. Postage  
Paid  
Hewlett-Packard  
Company

## HEWLETT-PACKARD JOURNAL

AUGUST 1973 Volume 24 • Number 12

Technical Information from the Laboratories of  
Hewlett-Packard Company

Hewlett-Packard S.A., CH-1217 Meyrin 2  
Geneva, Switzerland  
Yokogawa-Hewlett-Packard Ltd., Shibuya-Ku  
Tokyo 151 Japan

Editorial Director • Howard L. Roberts  
Managing Editor • Richard P. Dolan  
Contributing Editors • Ross H. Snyder,  
Laurence D. Shergalis

Art Director, Photographer • Arvid A. Danielson  
Art Assistant • Sue M. Reinheimer  
Administrative Services • Anne S. LoPresti  
European Production Manager • Kurt Hungerbühler

**CHANGE OF ADDRESS:** To change your address or delete your name from our mailing list please send us your old address label (it peels off). Send changes to Hewlett-Packard Journal, 1501 Page Mill Road, Palo Alto, California 94304 U.S.A. Allow 60 days.